

# Enter The World Of Reliable, High-End, Nano-Analylsis.



## **ZEISS Sigma Family**

Your Field Emission SEMs for High Quality Imaging  
and Advanced Analytical Microscopy

[zeiss.com/sigma](http://zeiss.com/sigma)



Seeing beyond

# Your Field Emission SEMs for High Quality Imaging and Advanced Analytical Microscopy

- › In Brief
- › The Advantages
- › The Applications
- › The System
- › Technology and Details
- › Service

The ZEISS Sigma family combines field emission SEM (FE-SEM) technology with an excellent user experience.

Structure your imaging and analysis routines and increase productivity with Sigma's intuitive 4-step workflow. You'll capture more data, faster than ever before. Choose from a variety of detector options to tailor Sigma precisely to your applications: you can image particles, surfaces, nanostructures, thin films, coatings and layers.

With the Sigma family you enter the world of high-end imaging: Sigma 300 delivers excellence in price and performance while Sigma 500's best-in-class EDS geometry delivers superb analytical performance.

Count on accurate, reproducible results – from any sample, every time.

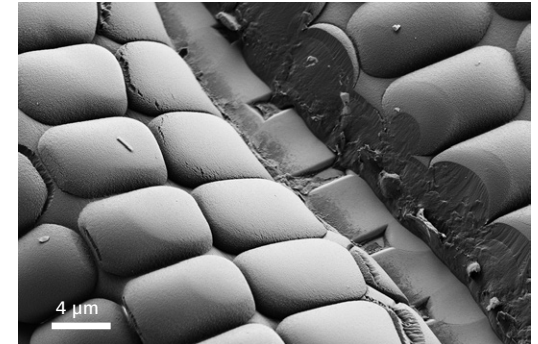

*Non-conductive CCD microlens array, 1 kV, Sigma 500.*

# Simpler. More Intelligent. More Integrated.

- › In Brief
- › **The Advantages**
- › The Applications
- › The System
- › Technology and Details
- › Service

## Use Flexible Detection for Clear Images

Tailor Sigma to your exact needs using the latest detector technology. Extract topography, composition and crystallographic information to characterize all of your samples. The annular backscatter detector (aBSD) expands imaging performance even further, acquiring both topographical and compositional information in a single detector. Among the benefits: improved sensitivity, increased signal-to-noise ratio, and more speed for your backscatter electron (BSE) image acquisition. A new generation of secondary electron (SE) detectors delivers high contrast and high resolution images. Working at low vacuum, you can expect crisp images with more contrast, thanks to Sigma's C2D and VPSE detectors.

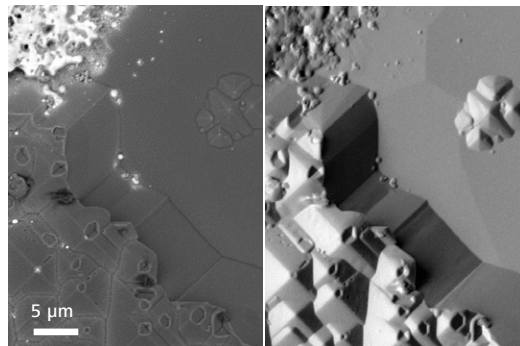

Gain information on topography and composition in a single detector. Solar cell, imaged with aBSD at 5 kV and high vacuum, left: compositional mode, right: topographical mode.

## Automate and Speed Up Your Workflow

A 4-step workflow lets you control all the functionality of your Sigma. This gives you the benefit of fast time-to-image and saves time on training, too – especially in a multi-user environment. The first step is Image Navigation, enabling intuitive sample navigation and positioning under the beam. Then, a simple mouse click sets the optimal imaging conditions for your sample. Next, use Automated Intelligent Imaging to define free-form regions of interest (ROIs) and automatically acquire multiple datasets across multiple samples. Finally, SmartSEM Touch collects and presents your data as an interactive map so you can understand your sample completely.

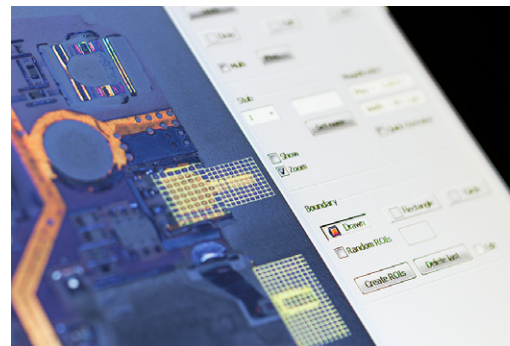

Save time with Sigma's intuitive 4-step workflow.

## Perform Advanced Analytical Microscopy

Sigma's best-in-class EDS geometry increases your analytical productivity, especially on beam sensitive samples. You will get analytical data at half the probe current and twice the speed. The Sigma family provides fast and complete X-ray analysis and mapping. By placing the detectors closer to the sample, you achieve complete shadow-free analytics. You'll profit from using a short analytical working distance of 8.5 mm and a take-off angle of 35°. You can rely on Sigma as your platform of choice for advanced analytical microscopy.

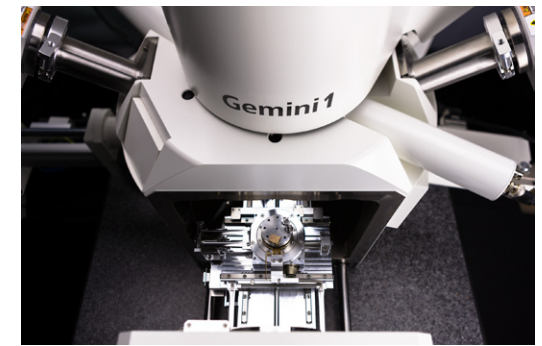

Speed up X-ray analyses with best-in-class EDS geometry.

## Your Insight into the Technology Behind It

- › In Brief
- › **The Advantages**
- › The Applications
- › The System
- › Technology and Details
- › Service

### Based on Proven Gemini Technology

The Sigma family is based on more than 20 years of perfecting the Gemini design. You can count on complete and efficient detection, excellent resolution and unsurpassed ease-of-use.

The Gemini objective lens design combines electrostatic and magnetic fields to maximize optical performance while reducing field influences at the sample to a minimum. This enables excellent imaging, even on challenging samples such as magnetic materials. The Gemini detection concept ensures efficient signal detection by detecting secondary (SE) and/or backscattered (BSE) electrons. This so-called Inlens detector is arranged on the optical axis, which reduces the need for realignment and thus minimizes time-to-image. Gemini beam booster technology guarantees small probe sizes and high signal-to-noise ratios, right down to ultra-low accelerating voltages. It also minimizes system sensitivity to external stray fields by keeping the beam at high voltage throughout the column until its final deceleration. These advanced features—the Gemini design, Inlens detection and beam booster technology—are shared by Sigma 300 and Sigma 500.

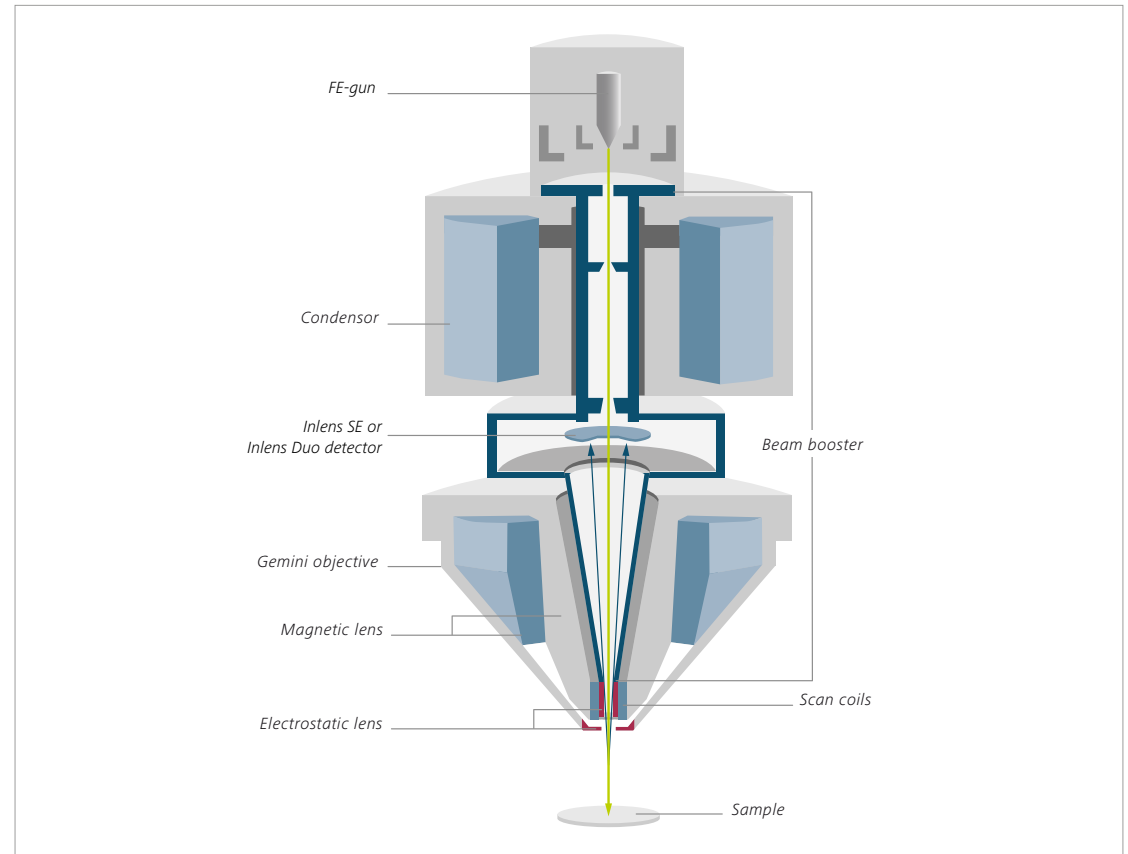

The Gemini 1 optical column comprises a beam booster, Inlens detector and a Gemini objective lens.

# Your Insight into the Technology Behind It

- › In Brief
- › **The Advantages**
- › The Applications
- › The System
- › Technology and Details
- › Service

**Use Flexible Detection for Clear Images**  
Characterize all of your samples with the latest detector technology.

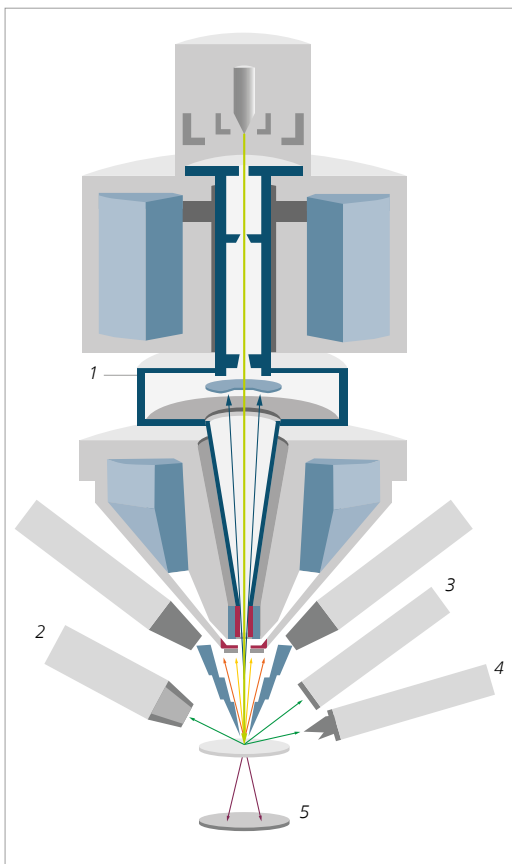

Schematic cross-section of Gemini 1 optical column with detectors.

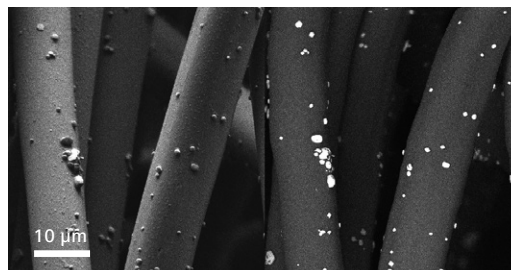

## 1 Inlens Detectors

*Inlens SE*: A high resolution in-column SE detector.  
*Inlens Duo\**: Inlens SE and BSE detector for sequential high resolution topographical and compositional imaging.

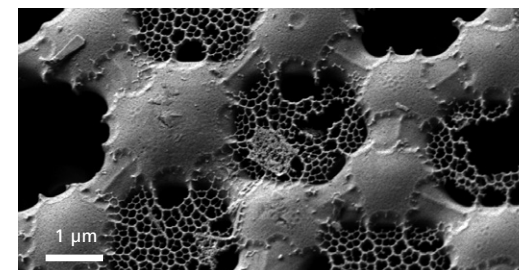

## 2 ETSE Detector

*Everhart-Thornley Secondary Electron Detector* for high resolution topographic imaging with increased signal-to-noise and reduced charging at low kV in high vacuum mode.



## 3 VPSE-G4

*4<sup>th</sup> generation Variable Pressure SE detector* provides improved imaging performance in VP mode with up to 85% more contrast.

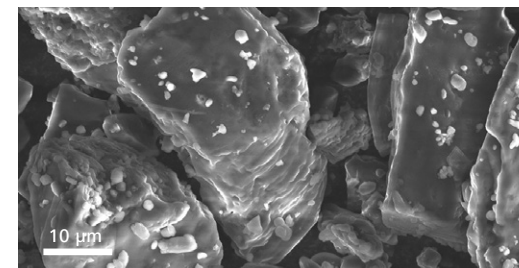

## 4 C2D

*Cascade Current Detector* that creates an ionization cascade and measures the resulting current. This provides crisp images in VP mode, even at higher pressures and lower voltages.



## 5 aSTEM

*Annular STEM detector* for producing high resolution transmission images. Provides brightfield, darkfield and high annular angular darkfield (HAADF) modes, e.g. of thin films or biological sections.

\*only available for Sigma 500

# Your Insight into the Technology Behind It

- › In Brief
- › **The Advantages**
- › The Applications
- › The System
- › Technology and Details
- › Service

## Use Flexible Detection for Clear Images

Characterize all of your samples with the latest detector technology.

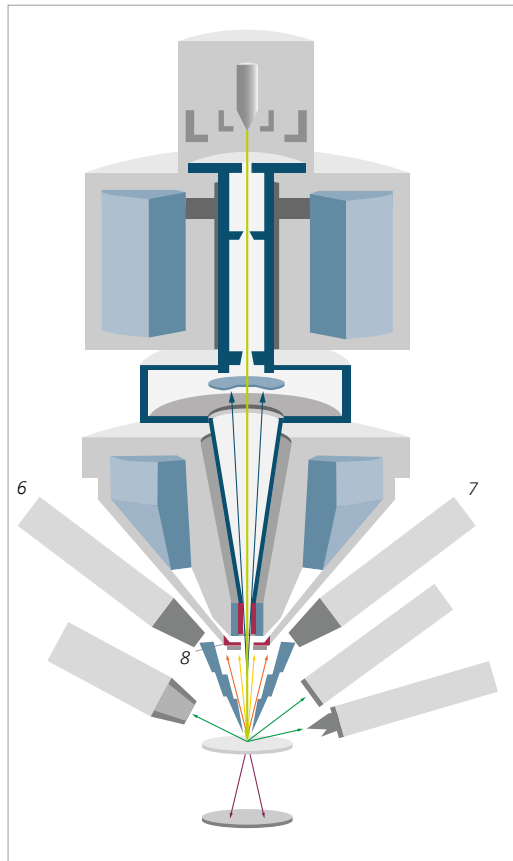

Schematic cross-section of Gemini 1 optical column with detectors.



### 6 / 7 Advanced EDS Detection

Advanced EDS analysis geometry of 8.5 mm working distance and 35° take-off angle for delivering data at twice the speed or half the probe current. Sample: courtesy of University of Leicester.

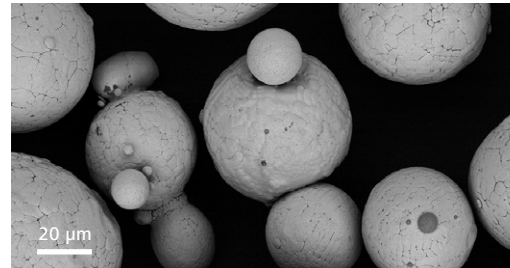

### 8 HDBSD

High definition BSE detector for excellent low kV compositional imaging of all samples in all vacuum modes.

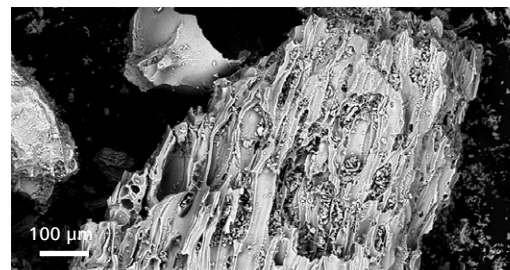

### 8 YAG-BSA

YAG crystal based scintillator BSE detector provides fast, easy compositional imaging.

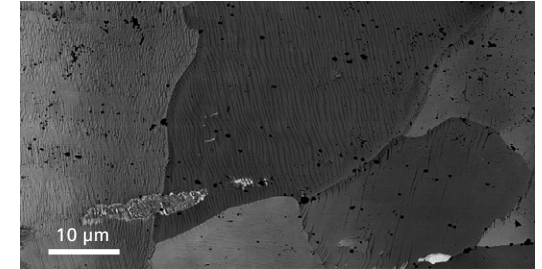

### 8 AsB Detector

Angular selective BSE detector for crystallographic and channeling contrast imaging of metals and minerals.

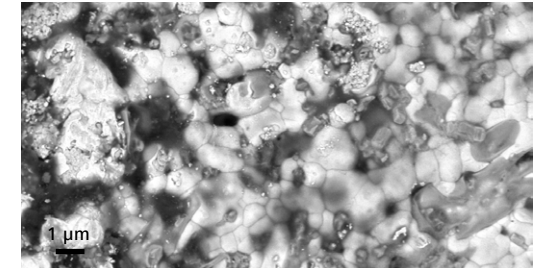

### 8 aBSD

Annular BSE detector for excellent low kV compositional imaging, crystalline surface analysis, and 3D surface modeling under all vacuum conditions.

# Your Insight into the Technology Behind It

- › In Brief
- › **The Advantages**
- › The Applications
- › The System
- › Technology and Details
- › Service

## Use Flexible Detection for Clear Images

The Everhart-Thornley Secondary Electron (ETSE) detector maximizes electron collection while minimizing charging effects. It delivers high resolution, high contrast images of conductive and non-conductive samples in high vacuum with an increase of up to 50% in signal-to-noise ratio. The 4<sup>th</sup> generation Variable Pressure Secondary Electron (VPSE-G4) detector compensates for charging effects by capturing images with up to 85% more contrast. The Cascade Current Detector (C2D) creates an ionization cascade and measures the resulting current. Thus it acquires stable, low noise images of beam-sensitive samples like polymers or biological samples up to 133 Pa. Sigma gives you a choice of three retractable backscatter detectors. The high-end aBSD with five annular segments provides high throughput, low-voltage compositional and topographical contrast imaging. Combine it with 3D surface modelling (3DSM) for quantitative 3D surface reconstructions. The manually retractable HDBSD with five segments provides high definition compositional and topographical contrast imaging. The YAG BSE detector grants ease of use and a fast response.

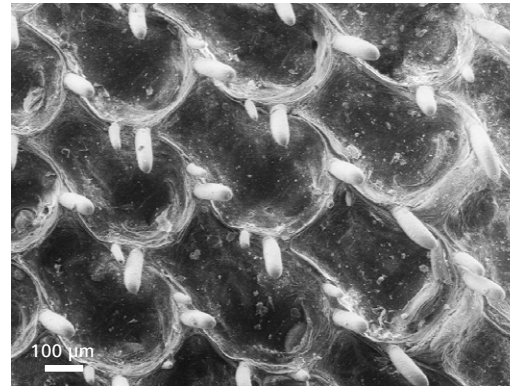

*Seaweed, imaged with VPSE-G4, at 15 kV and 40 Pa.*

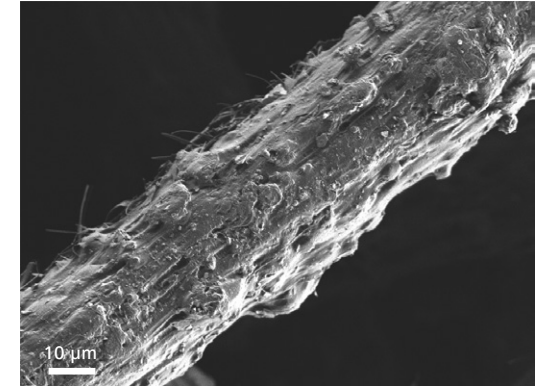

*The uncoated surface of a surgical face mask fibre imaged with ETSE at 1 kV, under high vacuum shows topographical information.*

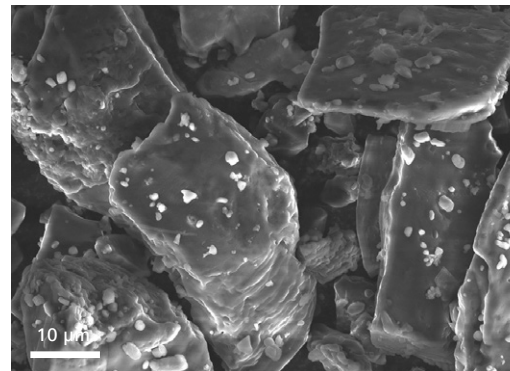

*Uncoated anti-inflammatory drug shows excellent surface detail at 10 kV and 35 Pa chamber pressure with C2D.*

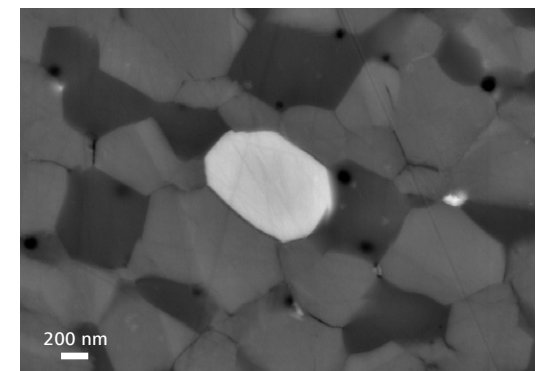

*Polished rock sample imaged at 10 kV with the aBSD detector.*

# Your Insight into the Technology Behind It

- › In Brief
- › **The Advantages**
- › The Applications
- › The System
- › Technology and Details
- › Service

## Automate and Speed Up Your Workflow

A 4-step workflow lets you control all the functionality of the Sigma family. It gives you the benefit of fast time-to-image and saves time on training, too – especially in a multi-user environment.

Navigate your sample quickly and easily with “real-world”, colored digital camera images.

One click sets the optimal imaging conditions for your sample, opening up access to novice users.

Identify and select regions of interest (ROIs) – automatically generate image datasets across batches of samples.

Review your data sets in context – collect and present your data as an interactive zoomable map.

### 1. Image Navigation

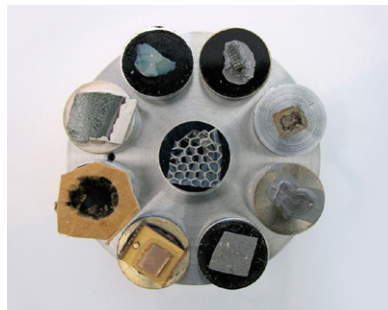

### 2. Sample Type Selection

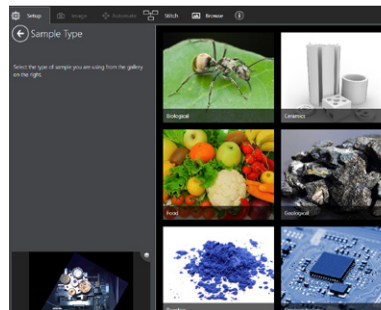

### 3. Automated Intelligent Imaging



### 4. SmartSEM Touch

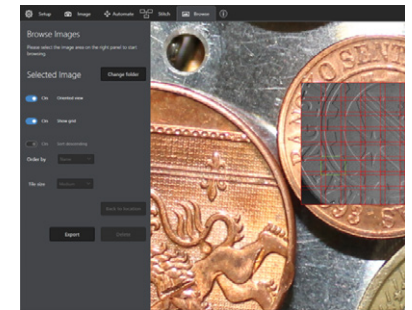



# Your Insight into the Technology Behind It

- › In Brief
- › **The Advantages**
- › The Applications
- › The System
- › Technology and Details
- › Service

## Raman Spectroscopic Imaging – Getting a Chemical Fingerprint

Combine your Sigma 300 with Raman imaging. Profit from the correlation of a research-grade Confocal Raman imaging (CRI) microscope with a ZEISS FE-SEM tailored for high quality imaging. Experience fully integrated Raman Imaging and Scanning Electron Microscopy (RISE).

### The Raman Spectroscopy Principle

Raman spectroscopy allows for the detection, identification and quantification of solid state materials through their unique vibrational and rotational energy level structure. The Raman effect, the underlying principle, is based on light interacting with the chemical bonds of a sample. Due to vibrations in the chemical bonds the interaction with photons causes specific energy shifts in the back scattered light that appear in a Raman spectrum. The Raman frequency  $\nu_{\text{Raman}}$  derives from the difference between the incident light frequency  $\nu_{\text{light}}$  and the transferred energy to the molecular bond with the frequency  $\nu_{\text{vib}}$ .

$$\nu_{\text{Raman}} = \nu_{\text{light}} \pm \nu_{\text{vib}}$$

Each Raman spectrum is unique for chemical composition and provides qualitative and quantitative information of the material: a chemical fingerprint. Raman spectroscopy is non-invasive and non-destructive, requires minimal, if any, sample preparation and can be used for imaging. CRI combines Raman spectroscopy with confocal microscopy and enables Raman imaging with the information of a complete spectrum at every image pixel and diffraction-limited resolution.

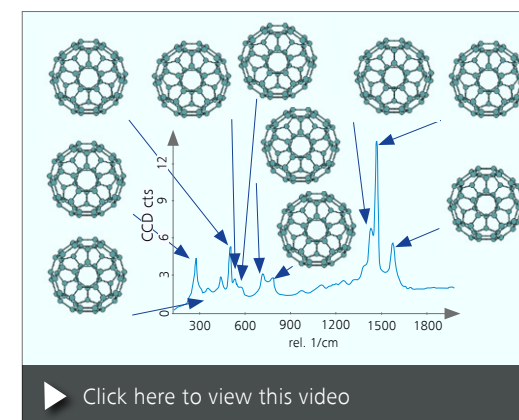
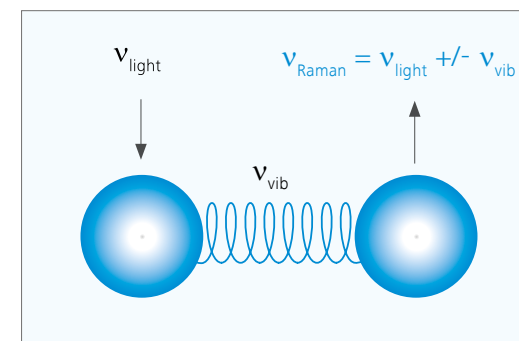

*Inelastic scattering by the molecular bonds in a sample (top) causes an energy shift of the excitation light. A Raman spectrum of Fullerene molecules (carbon molecules called C60, bottom) shows these energy shifts corresponding to the C60 vibration modes.*

# Your Insight into the Technology Behind It

- › In Brief
- › **The Advantages**
- › The Applications
- › The System
- › Technology and Details
- › Service

## Principle of RISE Microscopy – How it works

For RISE microscopy the region of interest of the sample is automatically transferred from one objective to the other. The sample stays within the vacuum chamber of the SEM during the entire measurement. That results in a streamlined workflow drastically improving ease of use. In a typical workflow the sample will be imaged with the SEM first, afterwards the stage will be moved automatically to the position of the Raman objective for subsequent Raman imaging.

Raman spectroscopy is a particularly powerful technique to detect chemical fingerprints on inorganic and organic materials. It can also be used to measure strain and stress, crystal polymorphs and orientation, doping and crystallinity. Thus it delivers complementary information to other analytical methods commonly used in an SEM, such as EDS.

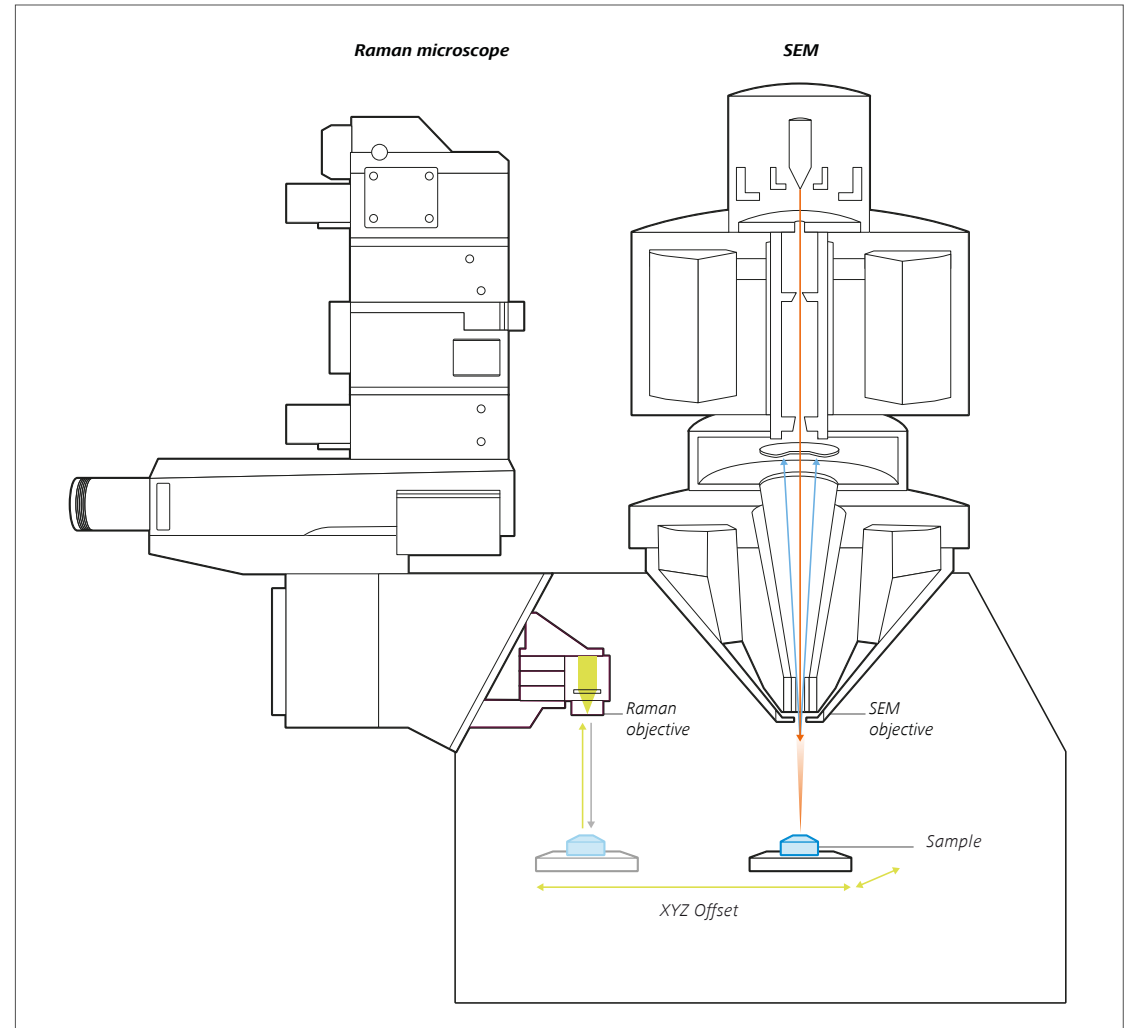

Principle of RISE Microscopy: The Raman microscope is attached to the chamber of the SEM. The sample is investigated with both microscopic techniques under vacuum in the SEM chamber. An integrated software module facilitates the workflow. (Raman beam green, SEM beam orange).

# Tailored Precisely to Your Applications

- › In Brief
- › The Advantages
- › **The Applications**
- › The System
- › Technology and Details
- › Service

Typical Application, Typical Samples	Task	ZEISS Sigma Family Offers
<b>Materials Research</b>	High resolution imaging and analysis of novel nano-materials	Sigma uses a variety of detectors to characterize nanomaterials comprehensively. Gain insights into topographical structure, even quantitatively, along with compositional detail, crystallographic structure and elemental distribution of engineered and novel materials.
	Analysis of coatings and thin films	The ETSE reveals previously hidden surface detail of uncoated, non-conductive particles in high vacuum mode. The aSTEM provides high resolution transmission images of thin film structures and nanoparticles. aBSD delivers crisp compositional information about coatings at low voltage.
	Characterization of various forms of carbon and other 2D materials	Combine high resolution SEM imaging and EDS elemental analysis with Raman spectroscopy imaging for analyzing graphene layers, properties of C60, the purity of carbon nanotubes (CNTs) and diamond-like carbon (DLC) coatings. Characterize defects, disorders and strain in carbon or other 2D materials.
	Imaging, analysis and differentiation of polymer materials	Differentiate various types of polymers with correlative microscopy using SEM and Raman. Analyze stress in fibers and laminate films. Determine crystallinity levels of polymers with high contrast images and Raman spectroscopic images.
	Performing battery research to understand aging effects and quality improvements	Combine high resolution SEM imaging and EDS elemental analysis of battery cathode and anode materials with Raman spectroscopic imaging. Gain comprehensive information on carbon anode, polymer separation foil, metal oxides and electrolytes. Keep air-sensitive samples in the SEM chamber under vacuum all the time.
<b>Life Sciences</b>	High resolution imaging and high throughput analysis of cryo-fixed biological samples	Image cell structures at the ultrastructural level with the aSTEM. The C2D delivers sharp images of beam sensitive and delicate biological specimens.
	Research on organic specimens like teeth, bone, collagen-containing bio-polymers like hair	Study non-conductive samples without coating with the Advanced VP mode or using low voltage approaches. Combine VP or low voltage with Confocal Raman Imaging to characterize biomaterials, such as shell, pearl, bone and tooth structure, or biopolymer like fingernails and hair.
<b>Geoscience and Mineralogy</b>	Complete characterization of minerals and rocks	Combine high resolution SEM imaging and EDS mapping with Raman spectral imaging to identify polymorphic forms of minerals. Characterize particle sizes and phase distribution in rock sections and differentiate organic from inorganic materials.
<b>Natural Resources</b>	Fast, accurate investigation of mineralogic core samples	Sigma allows imaging and high speed analysis of non-conductive geological samples in variable pressure mode.  Use aBSD to provide high definition compositional data of shale and minerals. Get compositional X-ray data twice as fast with two diametrically opposed EDS detectors with unparalleled solid angle geometry.
	Achieving high throughput in central laboratories	Profit from the chamber geometry that allows for up to 16 samples to be mounted at once.
	Correlative classification for phase distinction	Use correlate chemical analyses with vibrational spectroscopy to distinguish polymorphs.

# Tailored Precisely to Your Applications

- › In Brief
- › The Advantages
- › **The Applications**
- › The System
- › Technology and Details
- › Service

Typical Application, Typical Samples	Task	ZEISS Sigma Family Offers
Industrial Applications	Failure analysis of materials and manufactured components	<p>Inlens SE allows effortless acquisition of high resolution topographical information about failed engineered microstructures and MEMS devices.</p> <p>Use the aBSD detector to generate 3D surface metrology of precision-machined components. High contrast aBSD imaging lets you analyze and determine the cause of fractures and defects.</p> <p>The aBSD's surface-sensitive imaging supports high throughput identification of sample impurities by their compositional nature.</p>
	Imaging and analysis of steels and metals	Even large samples can be analyzed with the Cartesian stage. Maintain high image quality with <i>in situ</i> plasma cleaning and get crystallographic and channeling contrast of phases with the AsB. The aBSD simplifies the identification of non-metallic inclusions.
	Inspection of medical devices	The Sigma family lets you inspect the structure and coatings of stents and surgical guide wires. Working in VP mode, the C2D detector produces low-noise, highly-detailed images of coating imperfections.
	Characterization of semiconductor and electronic devices in process control and diagnostics	<p>Sigma 500's large airlock enables fast loading of 5" wafers, ready for inspection. Use the Inlens Duo to acquire high magnification compositional and topographical images of layered devices.</p> <p>Use the ETSE with enhanced performance in high vacuum mode to capture details of semiconductor devices and resists at low voltage.</p> <p>The fast, high-end aBSD detector with its improved low-voltage sensitivity increases throughput when you need to identify surface impurities or examine the crystallographic structure of bond contacts.</p>
	Getting a chemical fingerprint of semiconductor materials and devices by identifying their unique vibrational and rotational energy level structure	Use the SEM correlated with confocal Raman imaging to investigate stress, strain and crystal structure type or orientation, and to identify defects at high resolution.

# ZEISS Sigma at Work

- › In Brief
- › The Advantages
- › **The Applications**
- › The System
- › Technology and Details
- › Service

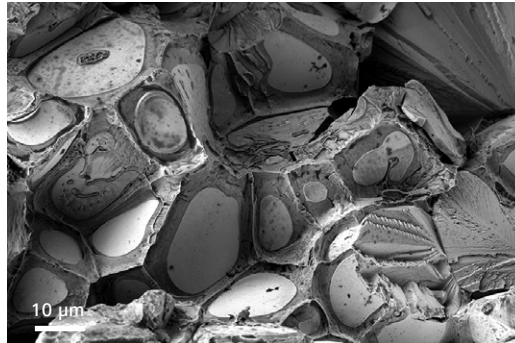

*Advanced alloy material imaged at 3 kV in high vacuum shows the tungsten core material surrounded by a steel matrix.*

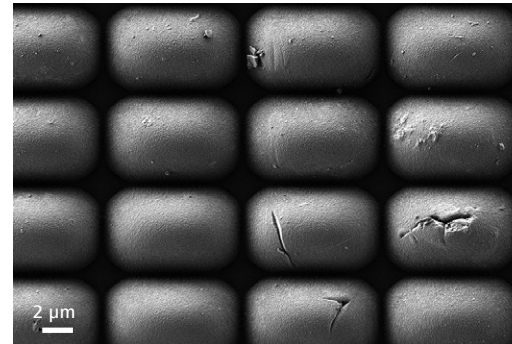

*Even at 300 V, the ETSE reveals high surface detail in surface defect inspection of non-conductive microlenses.*

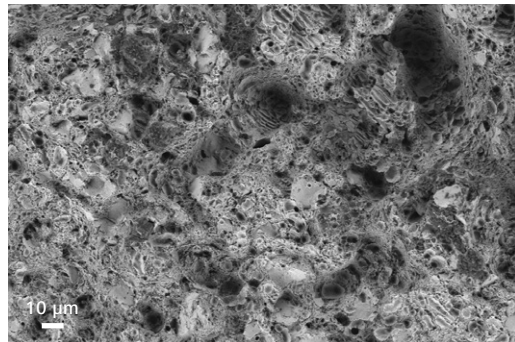

*The aBSD image reveals fractured metal surface morphology and delivers compositional information, even at a long working distance.*

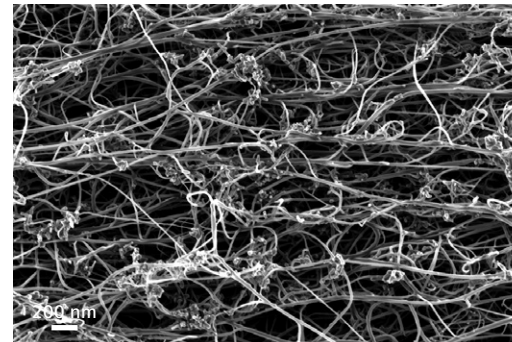

*Carbon nanofibers can be imaged easily and without damage to their delicate structure using the InLens SE detector at 1 kV in high vacuum.*

# ZEISS Sigma at Work

- › In Brief
- › The Advantages
- › **The Applications**
- › The System
- › Technology and Details
- › Service

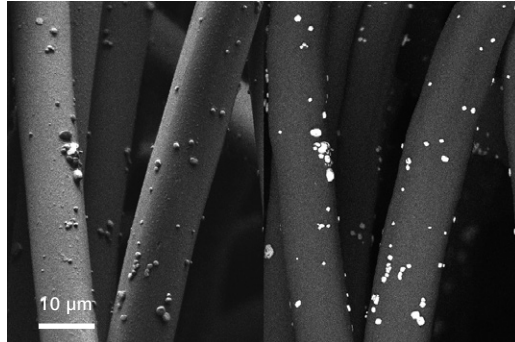

*Fibres with embedded silver nanoparticles, 1 kV, left: InLens Duo SE, right: InLens Duo BSE. Originate from antimicrobial dressings in wound care.*

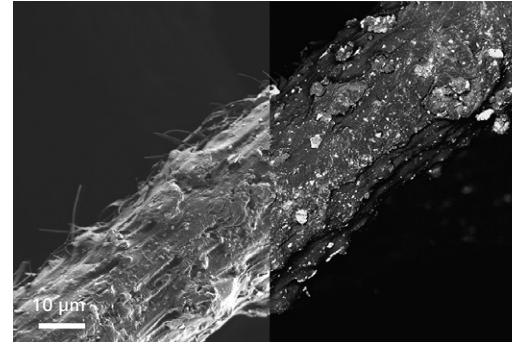

*The uncoated surface of a surgical face mask fibre imaged with both ETSE (left) and InLens BSE (right) detectors at 1 kV, under high vacuum conditions reveals topographical and compositional information.*

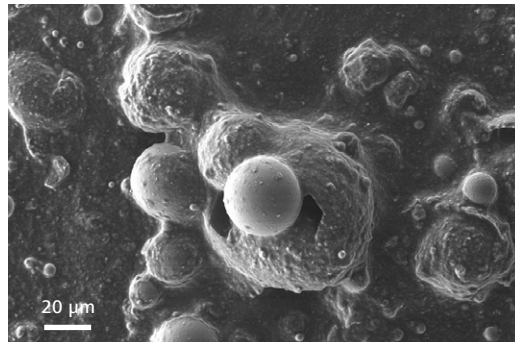

*Aluminum chlorohydrate from an aerosol antiperspirant obtained at 7 kV and 25 Pa chamber pressure with VPSE.*

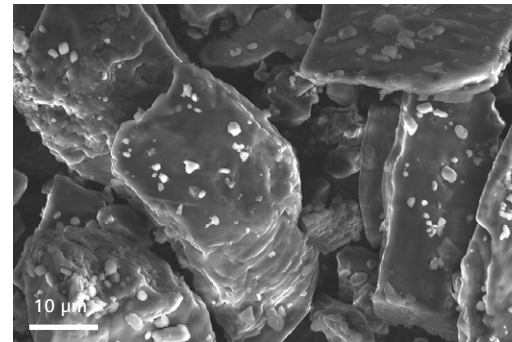

*Uncoated anti-inflammatory drug shows excellent surface detail at 10 kV and 35 Pa chamber pressure with C2D.*

# ZEISS Sigma at Work

- › In Brief
- › The Advantages
- › **The Applications**
- › The System
- › Technology and Details
- › Service



*Lanthanum carbonate imaged at 1 kV with InLens Duo BSE.  $\text{LaCO}_3$  is a phosphate binder used as a oral therapeutic agent for dialysis patients.*

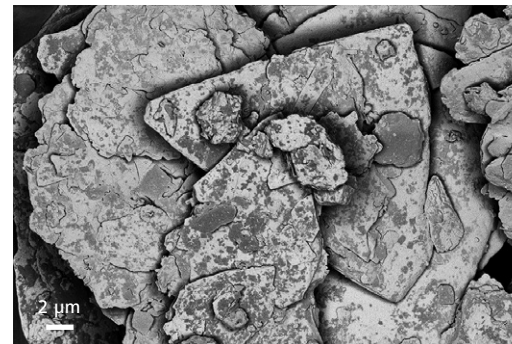

*The InLens Duo in BSE mode at 1 kV reveals the structure and compositional information of delicate lamellas of sericite mica and kaolin clays used as cosmetic fillers.*

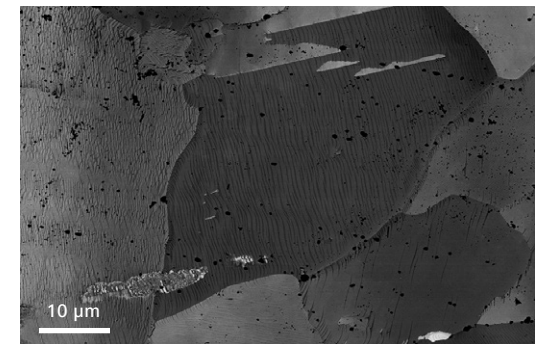

*Platinum grains showing grain boundary slip planes, imaged at 4 kV with AsB detector.*

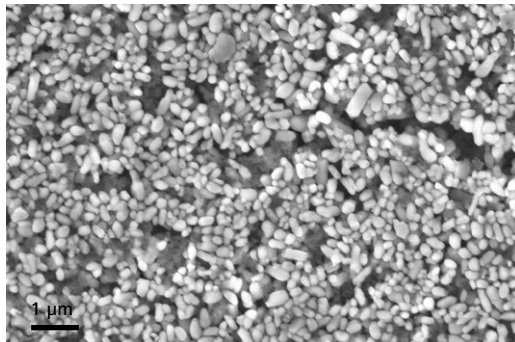

*Non-conductive titanium dioxide nanoparticles used as pigments and opacifying agents can be imaged easily at 40 Pa in VP mode with the C2D.*

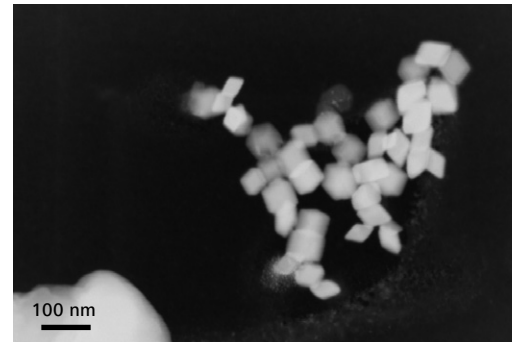

*25 – 50 nm iron oxide particles imaged with the aSTEM detector in darkfield mode at 20 kV.*



*Super alloy sample imaged at 1 kV with the aBSD.*

# ZEISS Sigma at Work

- › In Brief
- › The Advantages
- › **The Applications**
- › The System
- › Technology and Details
- › Service

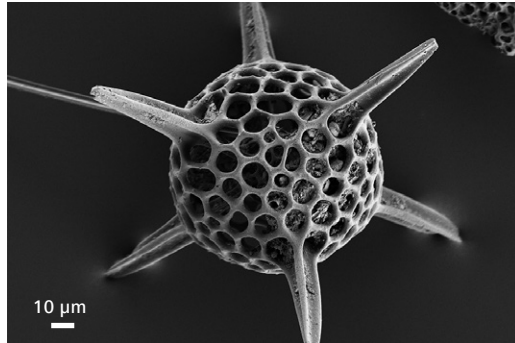

*The delicate open structure of a radiolarian is imaged effortlessly by the ETSE detector at 1 kV under high vacuum.*

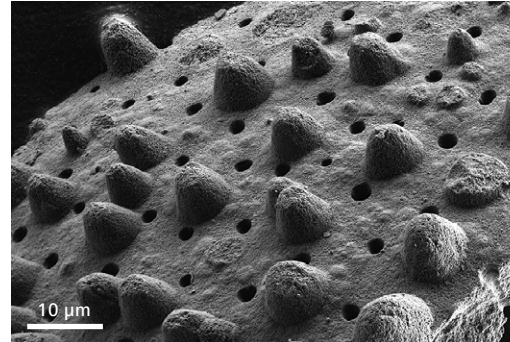

*The ETSE detector used at 3 kV in high vacuum clearly reveals surface detail and pores in the calcite wall of the planktonic foraminifera wall.*

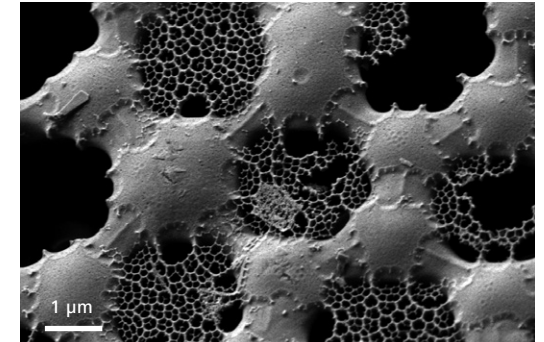

*The delicate open structure of a non-conductive diatom can be imaged at low kV in high vacuum without charging artefacts with the ETSE.*

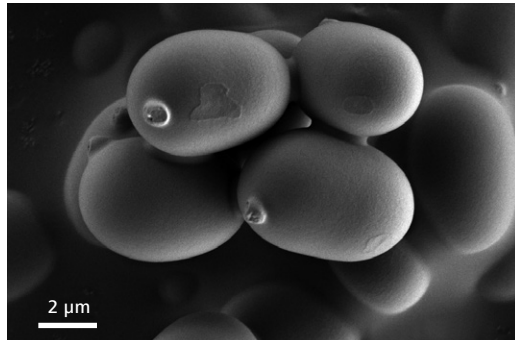

*Mushroom spores imaged at 1 kV at high vacuum. These delicate, fragile structures can be imaged easily with Sigma 500 at low voltage.*

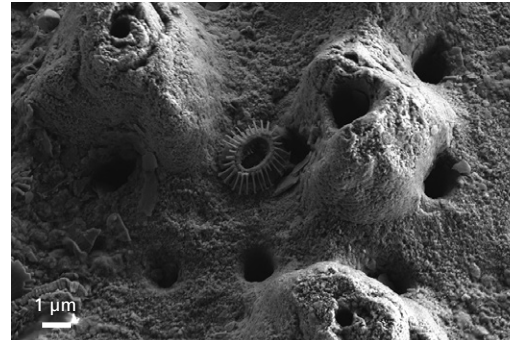

*Fine filtered, mixed sediment imaged with the ETSE under high vacuum at 3 kV.*



# ZEISS Sigma at Work

- › In Brief
- › The Advantages
- › **The Applications**
- › The System
- › Technology and Details
- › Service

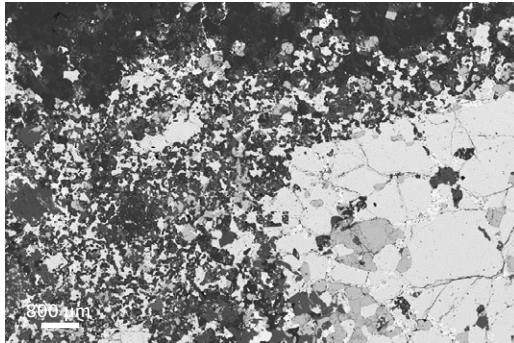

Nickel sulphide ore imaged in high definition by the BSE detector (HDBSD). Sample: of courtesy of the University of Leicester, UK.

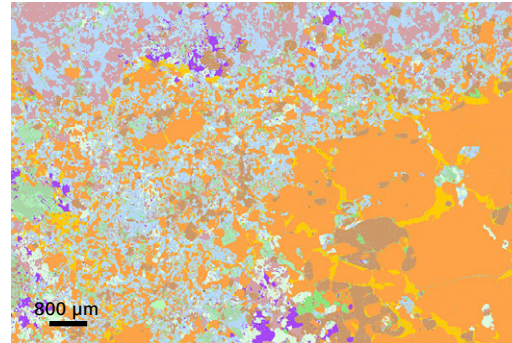

Nickel sulphide ore. Mineralogic mineral map generated from the HDBSD image on the right. Sample: courtesy of the University of Leicester, UK.

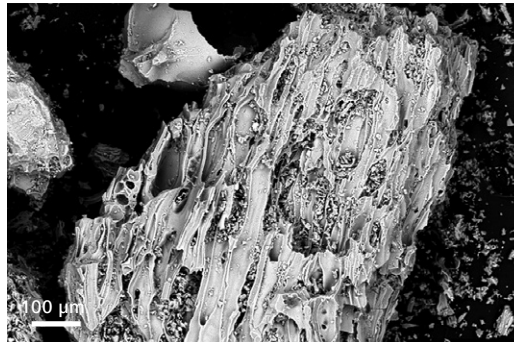

Rock sample imaged with the YAG-BSD at 20 kV.

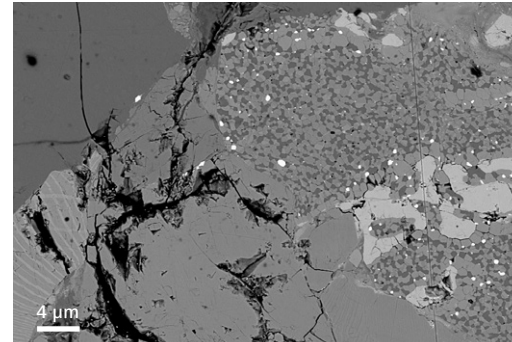

Rock sample imaged at 5 kV with the aBSD.

# ZEISS Sigma at Work

- › In Brief
- › The Advantages
- › **The Applications**
- › The System
- › Technology and Details
- › Service

## Raman Imaging of Biomaterials

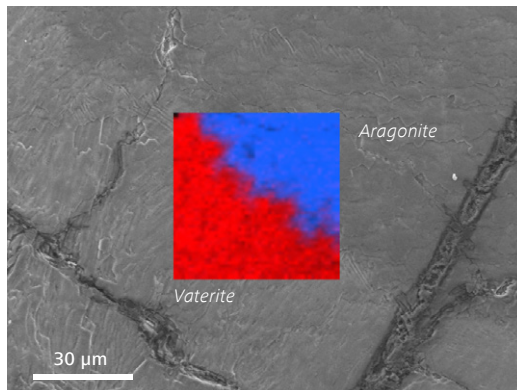

Pearl surface: This RISE image (left) makes it possible to differentiate between aragonite and vaterite phases. Both are  $\text{CaCO}_3$  polymorphs that are present in milky pearls. They have the same chemical compositions, but different crystal structures (Raman spectrum, right). Aragonite and vaterite can be clearly differentiated by means of Raman spectra.

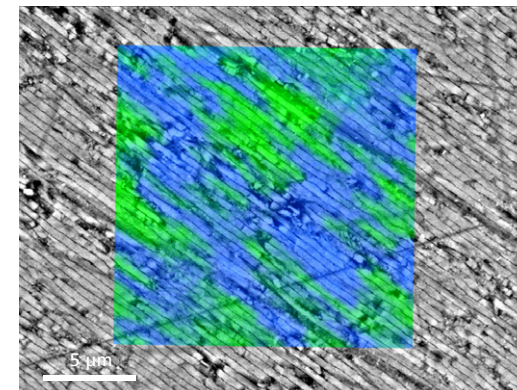
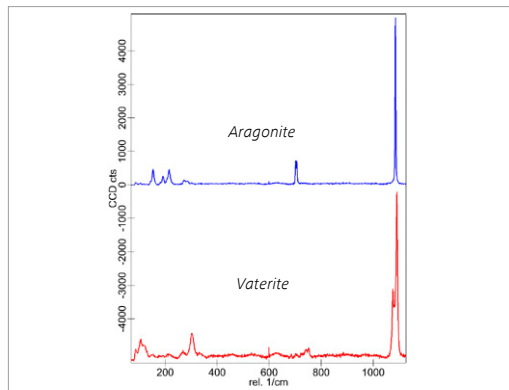

Polished cross-section of an abalone shell: Correlative RISE imaging shows the anisotropy of  $\text{CaCO}_3$  in the aragonite phase. The anisotropy of the nacre layers are detected here, with blue and green representing anisotropic lattice distortions in biogenic crystals.

## Raman Imaging of 2D Materials and Polymers

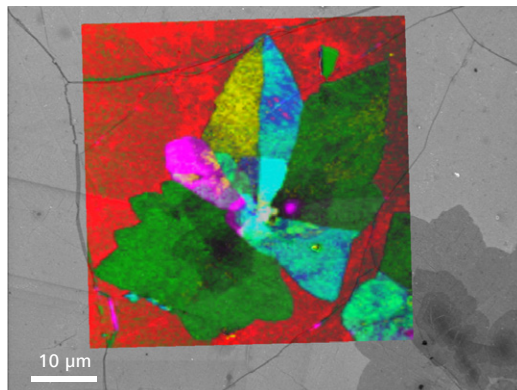

CVD-grown graphene layers: The red areas of the RISE image show a monolayer of graphene. The twist angles between the overlapped graphene films are determined by using Raman spectroscopic imaging. The twist angle  $>20^\circ$  is blue, twist angle  $3-8^\circ$  is green and twist angle  $12^\circ$  is purple.

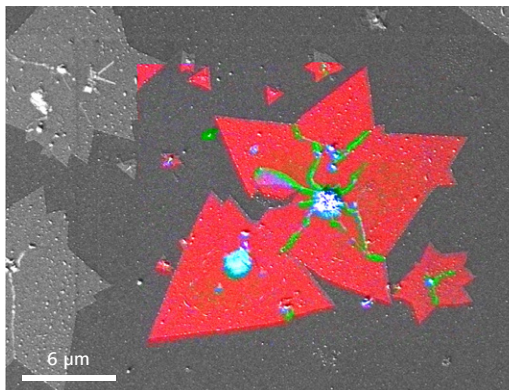

CVD-grown  $\text{MoS}_2$  2D crystals on  $\text{Si/SiO}_2$  substrate: The RISE image demonstrates wrinkles and overlapping parts of the  $\text{MoS}_2$  crystals (green), multilayers (blue) and single layers (red).

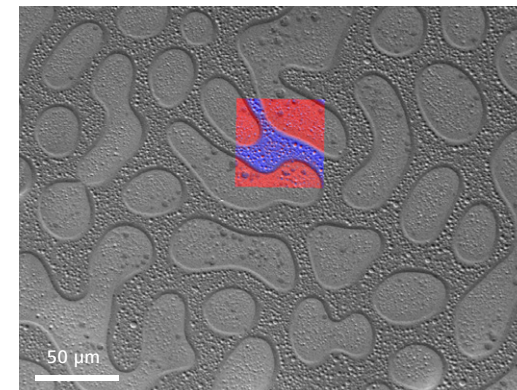

Polymer mixture of polystyrene (PS) and polymethyl methacrylate (PMMA): These two polymers form an immiscible blend. The domain structures are clearly imaged where PS is blue and PMMA is red.

# ZEISS Sigma at Work

- › In Brief
- › The Advantages
- › **The Applications**
- › The System
- › Technology and Details
- › Service

## Raman Imaging of Geological Samples

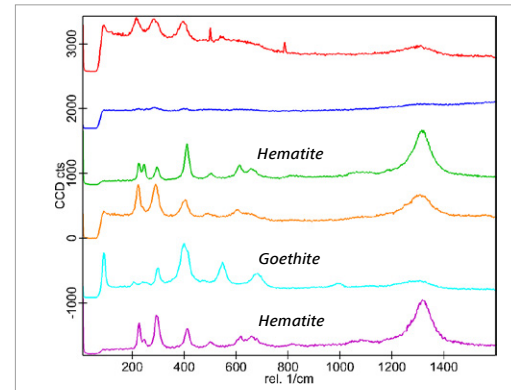
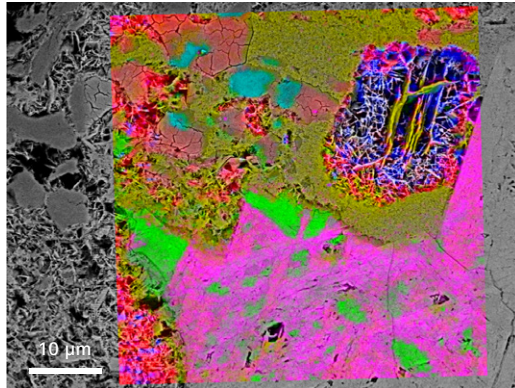

## Iron Mineralogy

Raman identification of iron ore minerals (RISE image, left). Differences in the spectra of hematite are attributed to the different orientations of the crystals (Raman spectrum, right: hematite is red, blue, green, orange and pink; goethite is light blue).

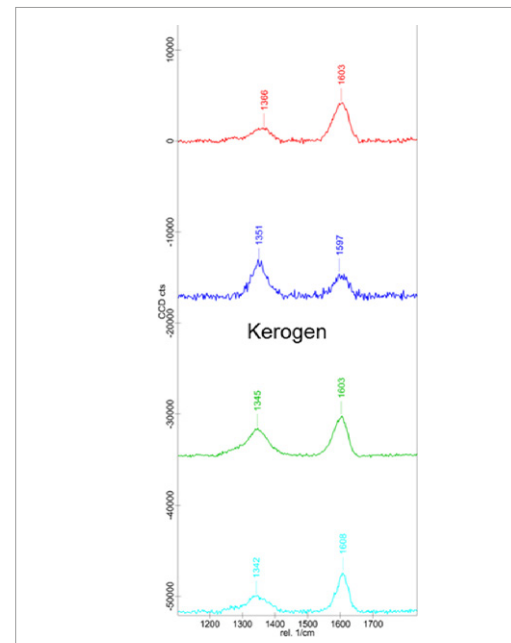
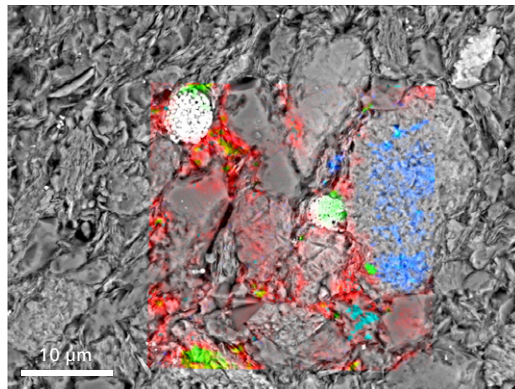

## Shale Mineralogy

Kerogen is a mixture of organic chemical compounds that make up a portion of the organic matter in sedimentary rocks. Raman allows you to identify and classify organic material sitting in the interstices of mineral phases. Mostly composed of lighter elements, these organics would not have been easily recognized by an EDS analysis. Since the FWHM (full width at half maximum) of the kerogen G-band (centered around 1600 / 1/cm) has been shown to be indicative of thermal maturity, you can also use RISE to get this enhanced level of information.

# Expand Your Possibilities

- › In Brief
- › The Advantages
- › **The Applications**
- › The System
- › Technology and Details
- › Service

## Reap the Benefits of Fully Integrated Raman Imaging in Scanning Electron Microscopy (RISE)

Maximize your Sigma 300 with confocal Raman imaging capability. Being able to recognize molecular and crystallographic fingerprinting will produce more information about your sample. Plus, it's ideal for performing 3D analysis and correlating SEM imaging, EDS and Raman mapping. Fully integrated RISE lets you take advantage of all the capabilities of both best-in-class SEM and Raman systems.

- Geometries are optimized when adapting the Raman system onto the SEM chamber so there's no compromise on SEM performance. Indeed, the SEM does not need to be modified at all.
- The sample only has to move the short distance from the Raman objective to the SEM objective. That means you will achieve excellent quality Raman and SEM results in a precise and fast way by streamlining your SEM-Raman workflow.
- You can investigate air-sensitive samples since the complete workflow is done under vacuum.
- Integration of the Raman system into the SEM chamber enables an automated sample transfer for seamless, fast and precise correlation of SEM imaging and Raman analytics.
- Your confocal images will have the best field flattening image properties, thanks to the long working distance objectives (ZEISS Objective LD EC Epiplan-Neofluar 100x/0.75).



Combine your Sigma 300 with Raman imaging



Watch how the sample is moved between LM and SEM objective.

# Expand Your Possibilities

- › In Brief
- › The Advantages
- › **The Applications**
- › The System
- › Technology and Details
- › Service

## Configure Your Stage – Choose from Eucentric or Cartesian

To allow complete flexibility of sample handling, Sigma 500 can be configured with either the eucentric or the Cartesian stage option. The eucentric stage offers a very stable, vibration-damped platform that delivers high resolution. Its mechanical eucentricity makes it easy to tilt your sample under the electron beam and is perfectly suited to high resolution imaging applications. The Cartesian stage with computerized movement comes into its own when you need to navigate bulky samples. Its modular design will accommodate extremely large and heavy samples – up to 150 mm in height and 5 kg in weight. The Cartesian stage is your first choice for demanding applications in fields like automotive, aerospace, metals or machinery.

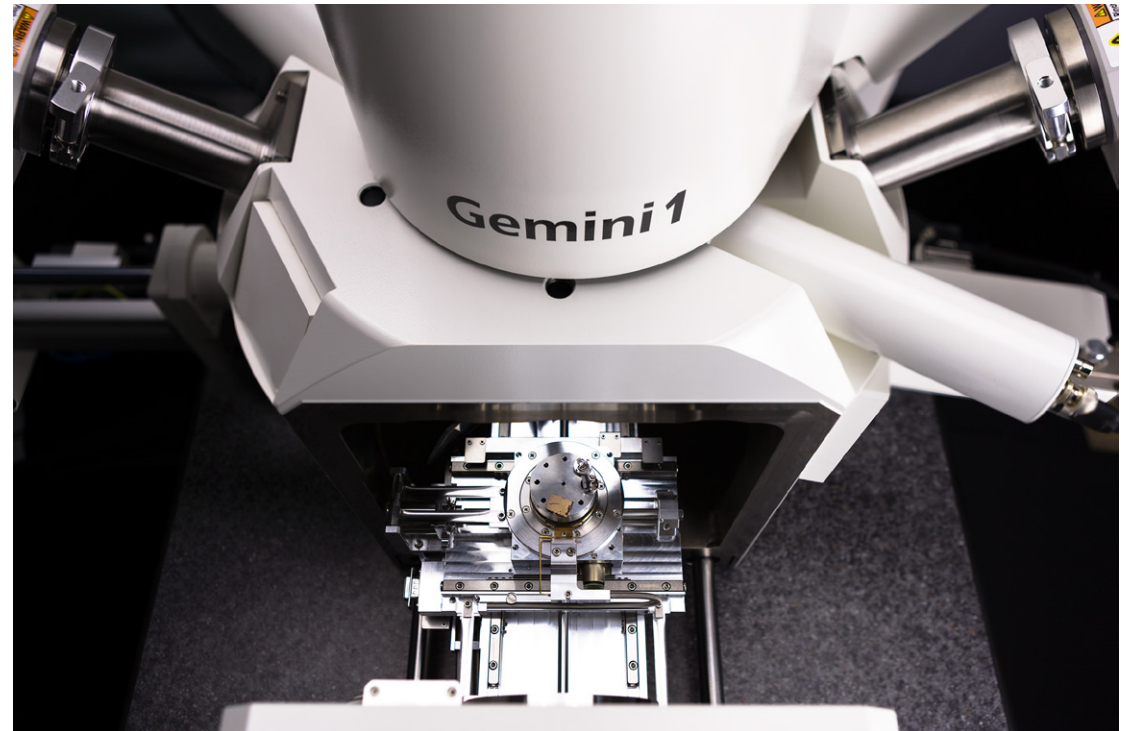

*Sigma 500 with Eucentric Stage.*

Parameter	Eucentric Stage	Cartesian Stage
Tilt	-3 to 70°	-10 to 90°
XY travel	130 mm	125 mm
Z travel	50 mm	38 mm
Weight	0.5 kg	0.5 kg XYZTR, 2 kg XYZR, 5 kg XY
Best for	High resolution imaging	Large, heavy samples
Applications	All high resolution applications (nanoparticles, thin films, etc.)	<ul style="list-style-type: none"> <li>■ Automotive piston QAQC</li> <li>■ Aerospace turbine blade failure analysis</li> <li>■ Inspection of large machined surfaces</li> </ul>

# Expand Your Possibilities

- › In Brief
- › The Advantages
- › **The Applications**
- › The System
- › Technology and Details
- › Service

## Get Quick Quantitative Information About Your Sample Surface Topography with 3DSM

Put user-friendly 3DSM software together with the aBSD detector to acquire a quantitative 3D model of your surface with a single click. The underlying “shape-from-shading” algorithm handles the reconstruction, using individual images taken by each of the four segments of the outer ring of the aBSD. The resulting 3D model will be visualized so you can perform basic measurements such as profile dimensions, and 2D- and 3D roughness evaluations directly—with just a few mouse clicks. For more sophisticated analysis methods, simply hand over the as-generated 3D model to the optional Mountains® software.

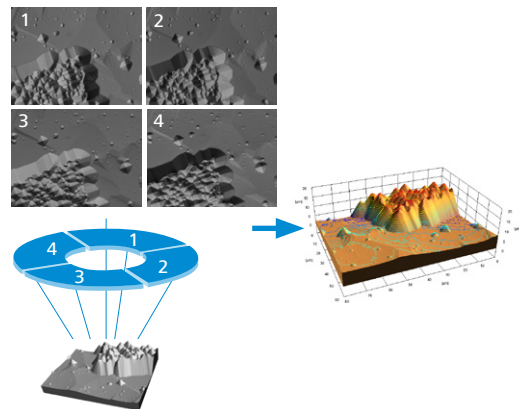

Working principle of the 3DSM method. Initially, separate images are acquired by each of the four segments of the diode, respectively. Different gradients of gray levels in each image can then be used to calculate the local height profile of the sample line by line.

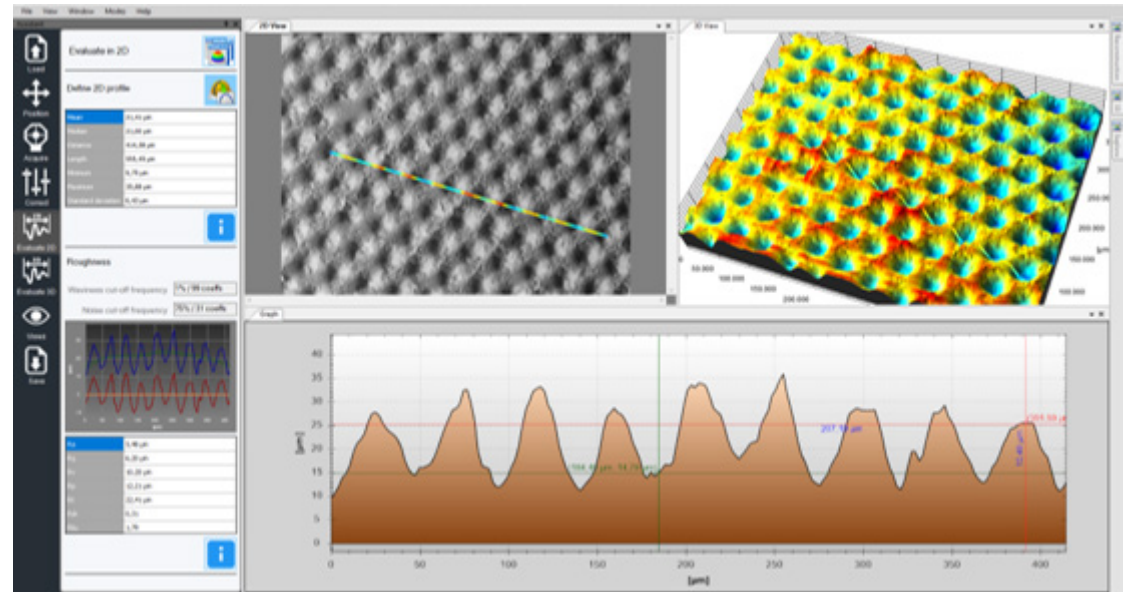

3D reconstruction of a “water-repelling” polyurethane film by roll-to-roll imprinting. 3D model of the surface, profile evaluation, and 2D- and 3D roughness determinations for quantitative assessment. Sample: courtesy of G. Umlauf, Fraunhofer IGB, Stuttgart, DE.

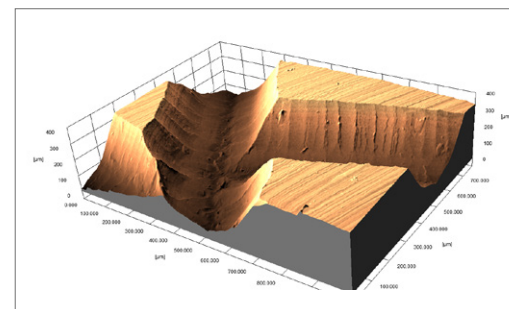

3D model of a machined and engraved steel surface.

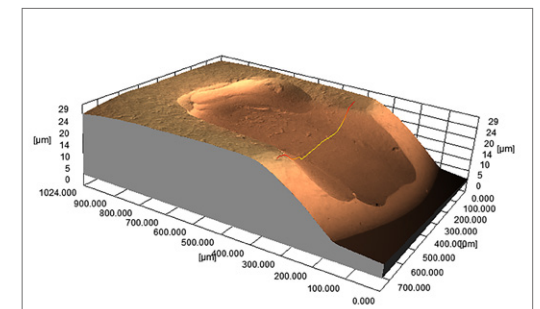

3D model of an imprint of the firing-pin left on a bullet.

# Expand Your Possibilities

- › In Brief
- › The Advantages
- › **The Applications**
- › The System
- › Technology and Details
- › Service

## Fast and Convenient 3D Imaging for Tissue Samples in the FE-SEM

Combine your Sigma 300 with 3View® technology from Gatan Inc. to acquire high resolution 3D data from resin embedded cell and tissue samples. In the shortest possible time and in the most convenient way, 3View® is an ultramicrotome inside the SEM chamber. The sample is continuously cut and imaged to produce thousands of serial images in a single day – each perfectly aligned because they are all generated from one fixed block. Sigma 300 from ZEISS is ideally suited to support this application. The unique Gemini column technology delivers high resolution transmission images and allows fields of view of hundreds of microns at nanometer resolution.

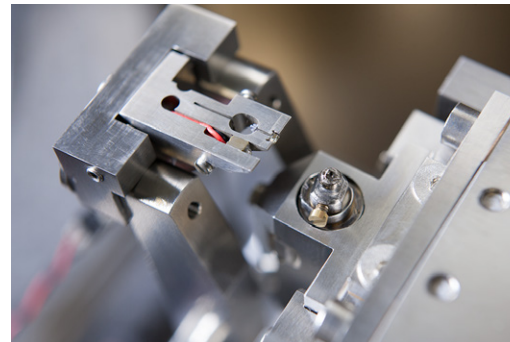
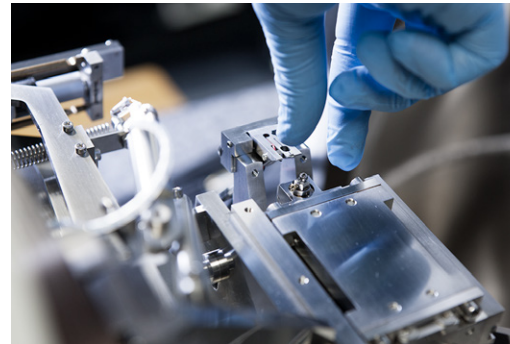

# Expand Your Possibilities

- › In Brief
- › The Advantages
- › **The Applications**
- › The System
- › Technology and Details
- › Service

## **Atlas 5 – Large Area Automated Imaging**

Atlas 5 turns your Sigma into a solution for rapid, automated mapping of large areas. With a 16 bit scan generator and dual super-sampling signal acquisition hardware, you can acquire single images up to 32 k × 32 k pixels, with dwell times from 100 ns to >100 s, adjustable in 100 ns increments. The solution lets you create large image montages resulting in a large Field of View image, at SEM nanometer scale resolution.

Efficient workflow-driven software guides you effortlessly through all imaging tasks while its many automated functions let you acquire data easier and faster than ever before. The optional Atlas 5 Array Tomography module is specifically designed for automated imaging of serial sections of biological tissue to enable 3D visualizations of large volumes.

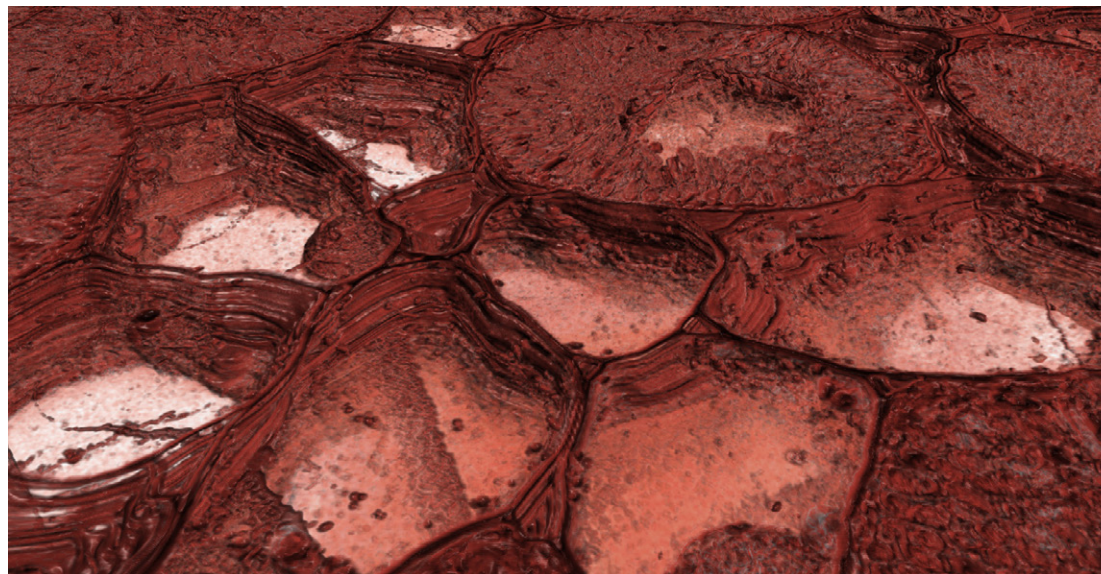

*3D visualization, Medicago sp., root nodules, serial sections, 25 nm pixel size, 3D spatial symbiotic relationships between nitrogen-fixing bacteria rhizobia and the host legume plant. Sample: courtesy of J. Sherrier, J. Caplan and S. Modla, University of Delaware, US.*



# Expand Your Possibilities

- › In Brief
- › The Advantages
- › **The Applications**
- › The System
- › Technology and Details
- › Service

## A Spotlight on Correlative Microscopy with ZEN Connect

Extend ZEN Connect with this easy-to-use software module. The module focusses on 2D applications and creates a productive and automated correlative workflow that overlays data from your light microscope and scanning electron microscope. By combining the optical contrast methods of the light microscope with the analytical methods of the electron microscope, you will discover new information about the function, structure and chemical composition of your sample.

### How it Works:

Using a special specimen holder with three fiducial markers, a coordinate system is generated within seconds. Use the light microscope to define interesting regions in your sample. Then relocate the defined regions in the electron microscope where you will be able to improve the resolution by several orders of magnitude. Now you can continue examining the sample more extensively. Finally, use ZEN Connect to correlate and export the images taken by the different microscopical techniques.

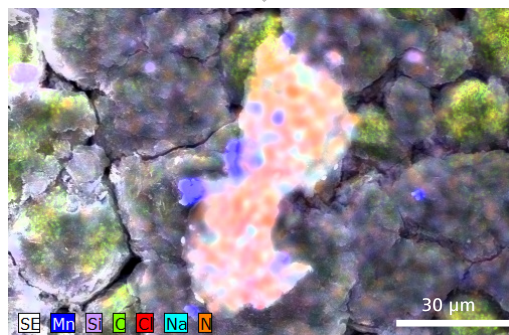
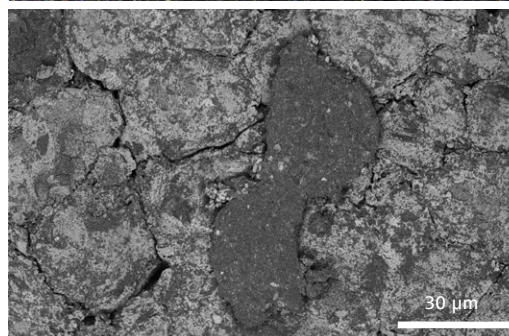

Lithium Ion battery. Top: light microscope image. Center: SEM image. Bottom: Overlay of both, combined with EDS analysis.

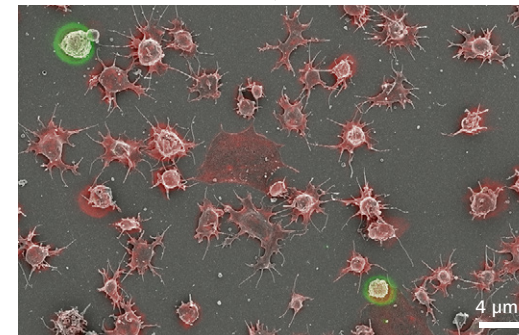
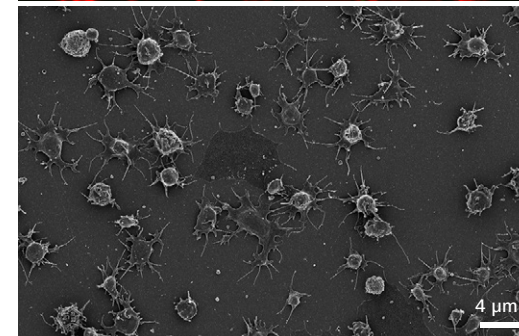
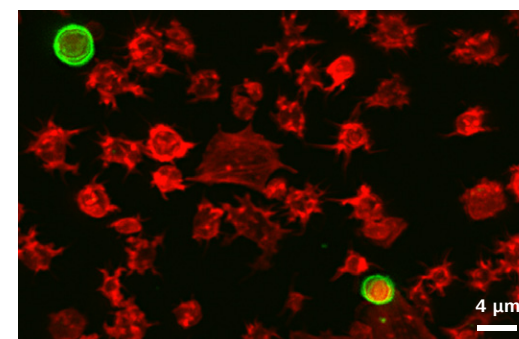

Platelets stained with AF647 (cellular platelet protein, false color: green) and AF555 – Phalloidin (false color: red). Top: Laser Scanning Microscopy fluorescence image. Center: SEM image. Bottom: Overlay. Courtesy: of D. Woulfe and J. Caplan, University of Delaware, Newark, USA.

# Expand Your Possibilities

- › In Brief
- › The Advantages
- › **The Applications**
- › The System
- › Technology and Details
- › Service

## Automated Particle Analysis

From manufacturing cleanliness and engine wear prediction to steel production and environmental management to additive manufacturing, particle analysis solutions from ZEISS automate your workflow for increased reproducibility.

### SmartPI

SmartPI (Smart Particle Investigator) is a powerful, all-in-one particle analysis tool for your ZEISS Sigma family. It automatically detects, investigates and characterizes particles of interest

in your sample by offering advanced image processing, image analysis and elemental analysis (EDS).

Gain additional productivity from your ZEISS Sigma family through automated analysis – for example, by running it fully unattended overnight and at weekends on repetitive samples. Generate standard reports automatically, or interactively investigate your data. Advanced particle analysis allows you to optimize industrial processes by quantifying samples rapidly and non-subjectively.

Application specific plug-ins provide pre-built recipes and report templates tailored specifically to the industry you are working in e.g. ISO 16232 or VDA 19.1 complying standard reports

Deep dive into the results for extensive data mining by using SmartPI Explorer; a standalone application which can run online & offline. SmartPI is an integrated solution from ZEISS that is supported entirely by global service and applications teams.

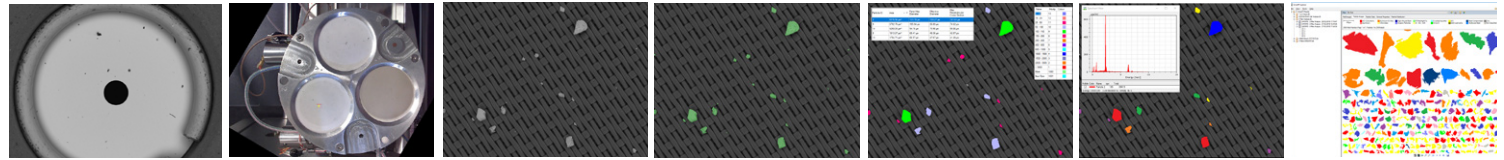

- Run-up the EM to the predefined conditions for the application
- Calibrate gun-alignment, filament saturation, EDS, brightness and contrast, etc
- Move the stage to the sample and analyse each field in the sample
- Capture the BSE field image of the sample
- Detect the particles from the background by image processing
- Measure and count particles using image analysis and classify on morphology
- EDS analyse each particle using Spot or Feature Scan and assign a material class
- Store the results in a database along with a full suite of modal data, ready for investigation and reporting

# Expand Your Possibilities

- › In Brief
- › The Advantages
- › **The Applications**
- › The System
- › Technology and Details
- › Service

## Automated Mineralogy

ZEISS Mineralogic combines an advanced mineral analysis engine with a range of application-specific outputs to your Sigma, enabling you to characterize and quantify even the most challenging geological samples with submicron precision.

## Oil & Gas

Use Mineralogic Reservoir as a part of your digital rock petrophysics workflow suite to gain a deeper understanding of your reservoir. This lets you automatically map and characterize the minerals, the porosity and the organics. Tailor your system to analyze any type of rock, from conventional sandstone reservoirs to highly heterogeneous shale and mudrocks. Your automated petrological system provides unique insights into reservoir rocks, playing a vital role in characterizing samples from the centimeter to the nanometer scale.

## Mining

Mineralogic Mining provides quantitative mineralogy for geometallurgy, optimization of mineral processing plant and ore characterization. Generate valuable understanding to support process modelling and decision-making, thereby reducing risks and costs. Target process improvements with quantitative mineralogy, elemental deportment, grain size distribution, and liberation and locking characteristics. Your automated mineralogy system is an essential part of the modern mining operation.

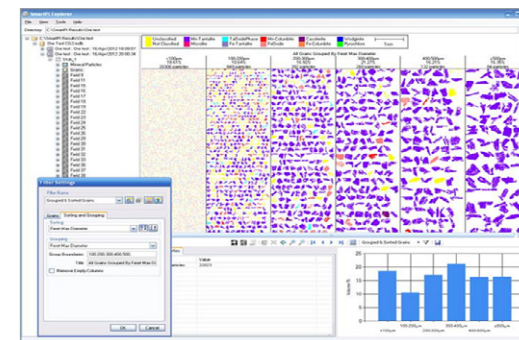

*Particle Analysis: Quickly and simply investigate plant products, identify trends and highlight process improvements. For example, identify causes for tailings losses and concentrate dilution*

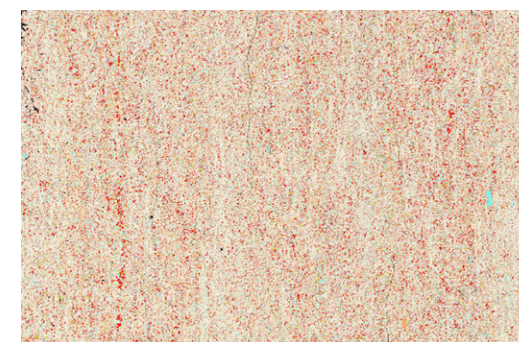

*Section Analysis: Typical Mineralogic digital mineral map of a section of rock identifying and quantifying mineralogy, porosity, organics and texture. Sample: courtesy of University of Texas, Austin, US.*

# Expand Your Possibilities

- › In Brief
- › The Advantages
- › **The Applications**
- › The System
- › Technology and Details
- › Service

## Make no Sacrifice to SEM Productivity even in Multi-user Environments

Depending on the actual laboratory environment, operation of the SEM can be the exclusive domain of expert electron microscopists. But this situation is challenged by the very common necessity that non-expert users, such as students, trainees, or quality engineers, also require data from the SEM. Sigma takes both requirements into account, with user interface options that cater to the operational needs of experienced microscopists as well as non-microscopists without sacrificing resolution or performance.



### System administrator

This user is responsible for calibrating the system and preconfiguring parameters, and will have full access to the system controls.



### Expert users Preferred UI: SmartSEM

Expert users have access to custom image directories, advanced imaging parameters, and analysis functions. They can have their own custom profiles that are independent from other user profiles.



### Novice users Preferred UI: SmartSEM Touch

Novice users have access to custom image directories, predefined workflows and the most frequently used parameters—perfect for a beginner. They can have their own custom profiles that are independent from other user profiles.

*Sigma perfectly meets the needs of multi-user environments with interface controls and options for users of different experience levels and access privileges.*

## Intuitive Operation: SmartSEM Touch

SmartSEM is ZEISS' well-established operating system for experienced microscopists that provides user access to advanced microscope settings. SmartSEM Touch is the highly simplified user interface developed specifically for the occasional operator who has very limited or no knowledge of operating an SEM. In as little as 20 minutes, novice users are up and running, producing their first SEM data. Laboratory managers can pre-configure parameters for recurring imaging routines, samples or parts, ensuring that novice or routine users always use the exact same parameters for repeatable data acquisition. Multiple languages are supported to ensure easy localization and use.

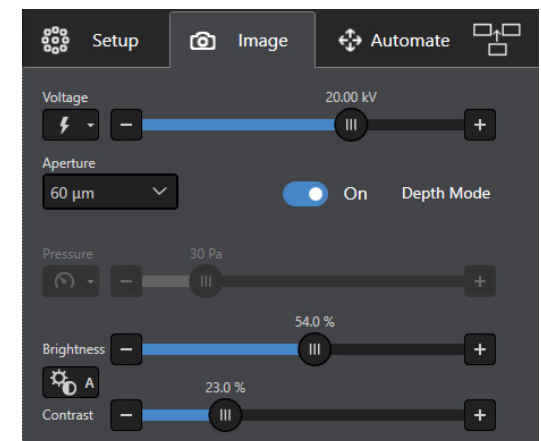

*SmartSEM Touch: Intuitive user interface for access to presets, workflows, and imaging parameters*

# Your Flexible Choice of Components

- › In Brief
- › The Advantages
- › The Applications
- › **The System**
- › Technology and Details
- › Service

Selected Detectors and Accessories	Detectors and Accessories Offer	ZEISS Sigma 300	ZEISS Sigma 300 VP	ZEISS Sigma 500	ZEISS Sigma 500 VP
Inlens SE Detector	High resolution in column topographical imaging	●	●	●	●
Inlens Duo Detector	High resolution in column sequential topographical or compositional imaging (replaces Inlens SE Detector)	X	X	○	○
ETSE Detector	High vacuum topographical imaging at longer working distance	●	●	●	●
VPSE-G4 Detector	Fourth generation Variable Pressure SE detector	X	○	X	○
C2D	Current cascade detector for high performance Variable Pressure imaging	X	○	X	○
AsB Detector, mounted to the objective	Compositional and crystallographic orientation imaging	○	○	○	○
aBSD Detector	Back-scattered electron detector for fast compositional and topographical contrast imaging at low voltage. Enables quantitative 3D surface reconstruction.	○	○	○	○
5S HBSD Detector	5 segment high definition BSE detector for compositional imaging	○	○	○	○
YAG-BSD Detector	YAG crystal scintillator BSE detector for fast, easy-to-use compositional imaging	○	○	○	○
aSTEM Detector	Annular STEM for transmission imaging	○	○	○	○
CL Detector	Cathodoluminescence detector	○	○	○	○
3DSM	3D quantitative solutions for 3D reconstructions of your sample surface and for local roughness analysis (aBSD is included).	○	○	○	○
Airlock	Fast loading of samples up to 80 mm diameter	○	○	○	○
Large Airlock	Fast loading of samples up to 130 mm diameter	X	X	○	○
Plasma Cleaner	Remove hydrocarbon contamination for high resolution imaging	○	○	○	○
3View	Serial block face imaging of biological samples	X	○	X	X
SmartEDX Detector	Dedicated ZEISS energy dispersive X-ray analysis solution for microanalysis applications	○	○	○	○
EBSD Detector	Electron backscatter diffraction detector for microstructural-crystallographic analysis	○	○	○	○
EDS Detector	Energy dispersive X-ray analysis for high resolution compositional analysis	○	○	○	○
WDS Detector	Wavelength dispersive spectroscopy for high resolution low artefact compositional analysis	○	○	○	○
RISE	Integrated solution for confocal Raman imaging	○	○	X	X
SmartPI	Automated particle analysis	○	○	○	○
Mineralogic Mining	Advanced mineral analysis engine	○	○	X	X
SmartSEM Touch	Simplified user-interface for multi-user environments	○	○	X	X

● Standard ○ Option available X Not available

# Your Flexible Choice of Components

- › In Brief
- › The Advantages
- › The Applications
- › **The System**
- › Technology and Details
- › Service



## Learn How to Configure your ZEISS Sigma with 3D Confocal Raman Imaging

Extend the capacity of your ZEISS Sigma 300 RISE. Get to know the basic requirements and profit from a variety of upgrades and options.

### RISE configurable on ZEISS Sigma 300 / ZEISS Sigma 300 VP

#### Basic Requirements

- Raman confocal microscope set-up (532 nm with 75 mW or 30 mW laser)
- Adapter flange, CCD and software for navigation, laser safety interlock for laser class 1M

#### Upgrades and Options

CCD camera upgrade	Back-illuminated CCD
Spectrometer upgrade	Broadband spectrometer
Premium upgrade	Optimized detection system (2 spectrometers and back-illuminated deep depletion CCD)
Additional lasers	478 nm with 75 mW
	633 nm with 35 mW
	785 nm with 120 mW
Database	Database management software and spectral database

# Technical Specifications

- › In Brief
- › The Advantages
- › The Applications
- › The System
- › **Technology and Details**
- › Service

	ZEISS Sigma 300	ZEISS Sigma 500
Electron Source	Schottky Thermal Field Emitter	Schottky Thermal Field Emitter
Resolution* at 30 kV (STEM)	1.0 nm	0.8 nm
Resolution* at 15 kV	1.0 nm	0.8 nm
Resolution* at 1 kV	1.6 nm	1.3 nm
Resolution* at 30 kV (VP Mode)	2.0 nm	1.5 nm
Backscatter Detector (BSD)	aBSD / HDBSD	aBSD / HDBSD
Maximum Scan Speed	50 ns/pixel	50 ns/pixel
Accelerating Voltage	0.02 – 30 kV	0.02 – 30 kV
Magnification	10x – 1,000,000x	10x – 1,000,000x
Probe Current	3 pA - 20 nA (100 nA optional)	3 pA - 20 nA (100 nA optional)
Image Framestore	32 k × 24 k pixels	32 k × 24 k pixels
Ports	10	14
EDS Ports	2 (1 dedicated port)	3 (2 dedicated ports)

*\*optimum working distance; upon final installation, the resolution is proven in the systems acceptance test at 1 kV and 15 kV in high vacuum*

## Vacuum Modes

High Vacuum	Yes	Yes
Variable Pressure	10-133 Pa	10 – 133 Pa
Stage Type	5 axis compucentric stage	5 axis eucentric stage 5 axis compucentric stage option
Stage travel X	125 mm	130 mm 125 mm
Stage travel Y	125 mm	130 mm 125 mm
Stage travel Z	50 mm	50 mm 38 mm
Stage travel T	-10 to +90 degrees	-4 to +70 degrees -10 to +90 degrees
Stage travel R	360° Continuous	360° Continuous 360° Continuous

# Count on Service in the True Sense of the Word

- › In Brief
- › The Advantages
- › The Applications
- › The System
- › Technology and Details
- › **Service**

Because the ZEISS microscope system is one of your most important tools, we make sure it is always ready to perform. What's more, we'll see to it that you are employing all the options that get the best from your microscope. You can choose from a range of service products, each delivered by highly qualified ZEISS specialists who will support you long beyond the purchase of your system. Our aim is to enable you to experience those special moments that inspire your work.

## **Repair. Maintain. Optimize.**

Attain maximum uptime with your microscope. A ZEISS Protect Service Agreement lets you budget for operating costs, all the while reducing costly downtime and achieving the best results through the improved performance of your system. Choose from service agreements designed to give you a range of options and control levels. We'll work with you to select the service program that addresses your system needs and usage requirements, in line with your organization's standard practices.

Our service on-demand also brings you distinct advantages. ZEISS service staff will analyze issues at hand and resolve them – whether using remote maintenance software or working on site.

## **Enhance Your Microscope System.**

Your ZEISS microscope system is designed for a variety of updates: open interfaces allow you to maintain a high technological level at all times. As a result you'll work more efficiently now, while extending the productive lifetime of your microscope as new update possibilities come on stream.



*Profit from the optimized performance of your microscope system with services from ZEISS – now and for years to come.*

>> [www.zeiss.com/microservice](http://www.zeiss.com/microservice)





**Carl Zeiss Microscopy GmbH**  
07745 Jena, Germany  
microscopy@zeiss.com  
www.zeiss.com/sigma